







 Ø6,3x50 mm A1 x 30	 Ø12 mm A2 x 30	 4 mm A3 x 1	 Ø15x12 mm B1 x 8	 Ø5x44 mm B2 x 8
 Ø20 mm B3 x 8	 Ø4x16 mm D1 x 16	 Ø3x25 mm D2 x 8	 Ø1,6x25 mm F x 68	 Ø8x36 mm G x 16
 M x 4	 Ø15 mm N x 8	 Z x 8		

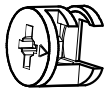
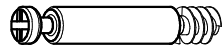

Box 1 / 2

1400x400x16 mm

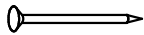
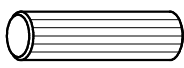
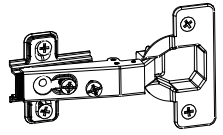
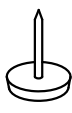

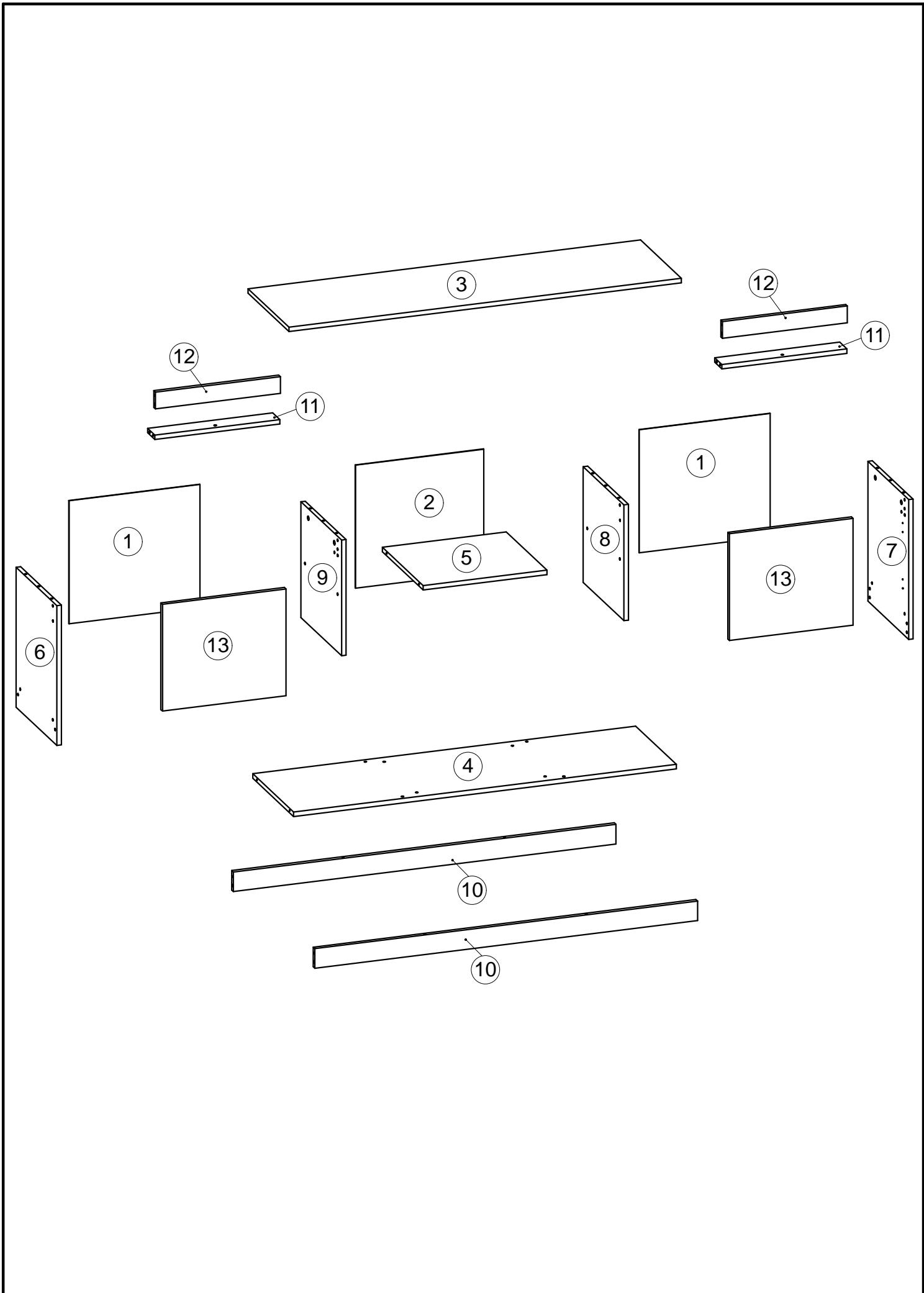
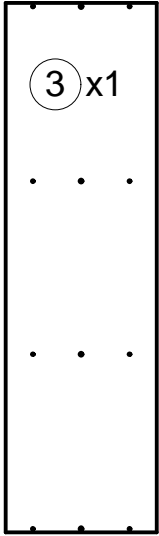
1366x399x16 mm



442x399x16 mm

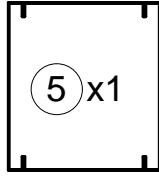

499x399x16 mm

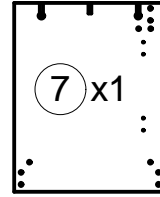

1366x70x16 mm

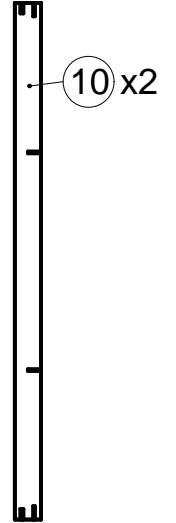

499x399x16 mm

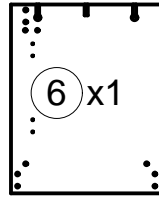

413x399x16 mm

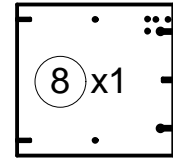

413x399x16 mm

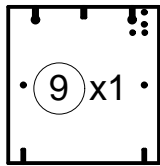

446x70x16 mm

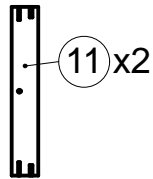

446x60x16 mm

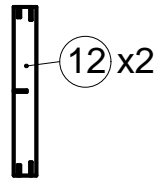

Fittings & Tools

Box 2 / 2

467x439x3 mm

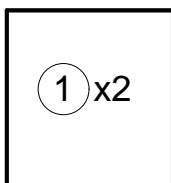

458x439x3 mm

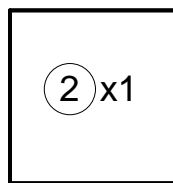

440x380x16 mm

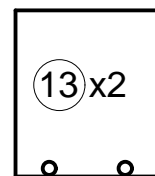

1

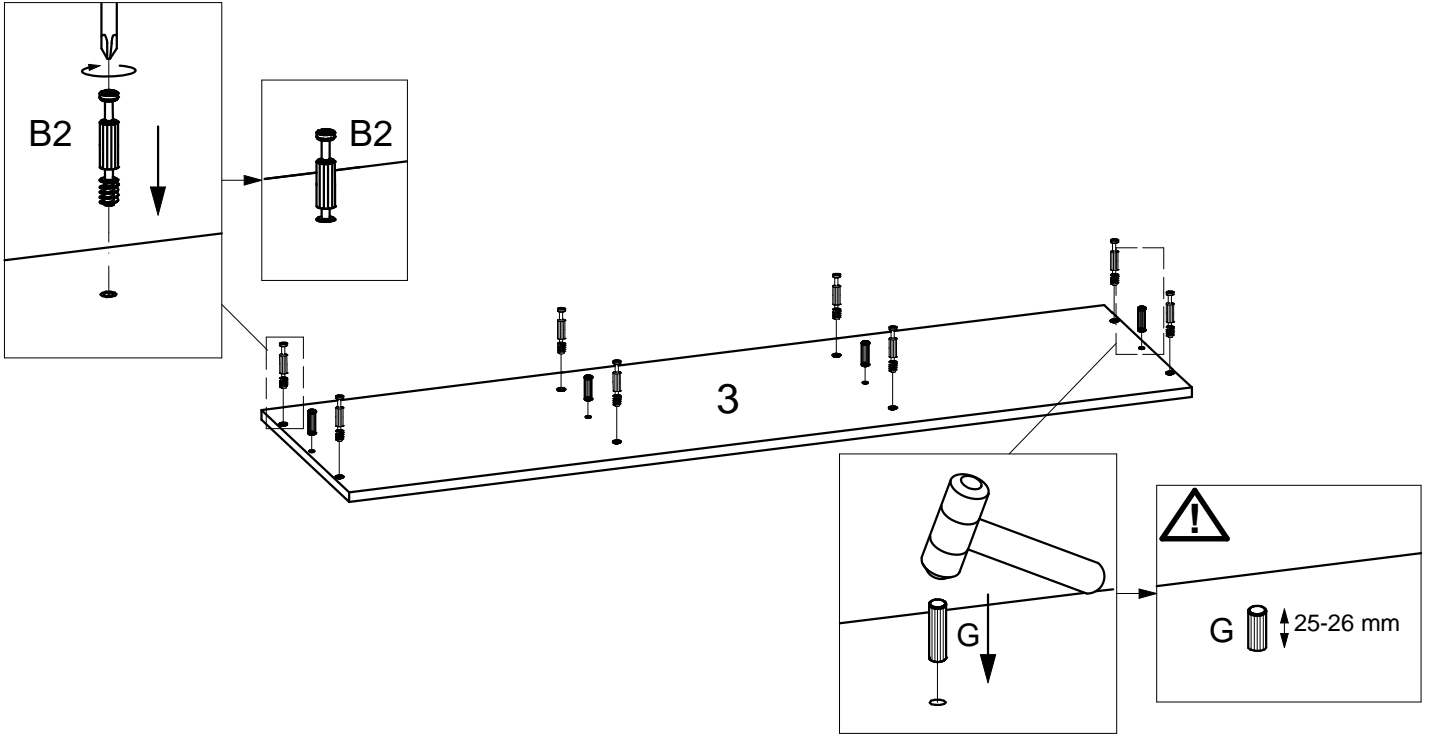
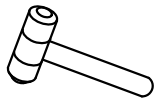
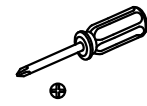
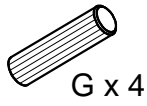
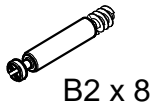

2

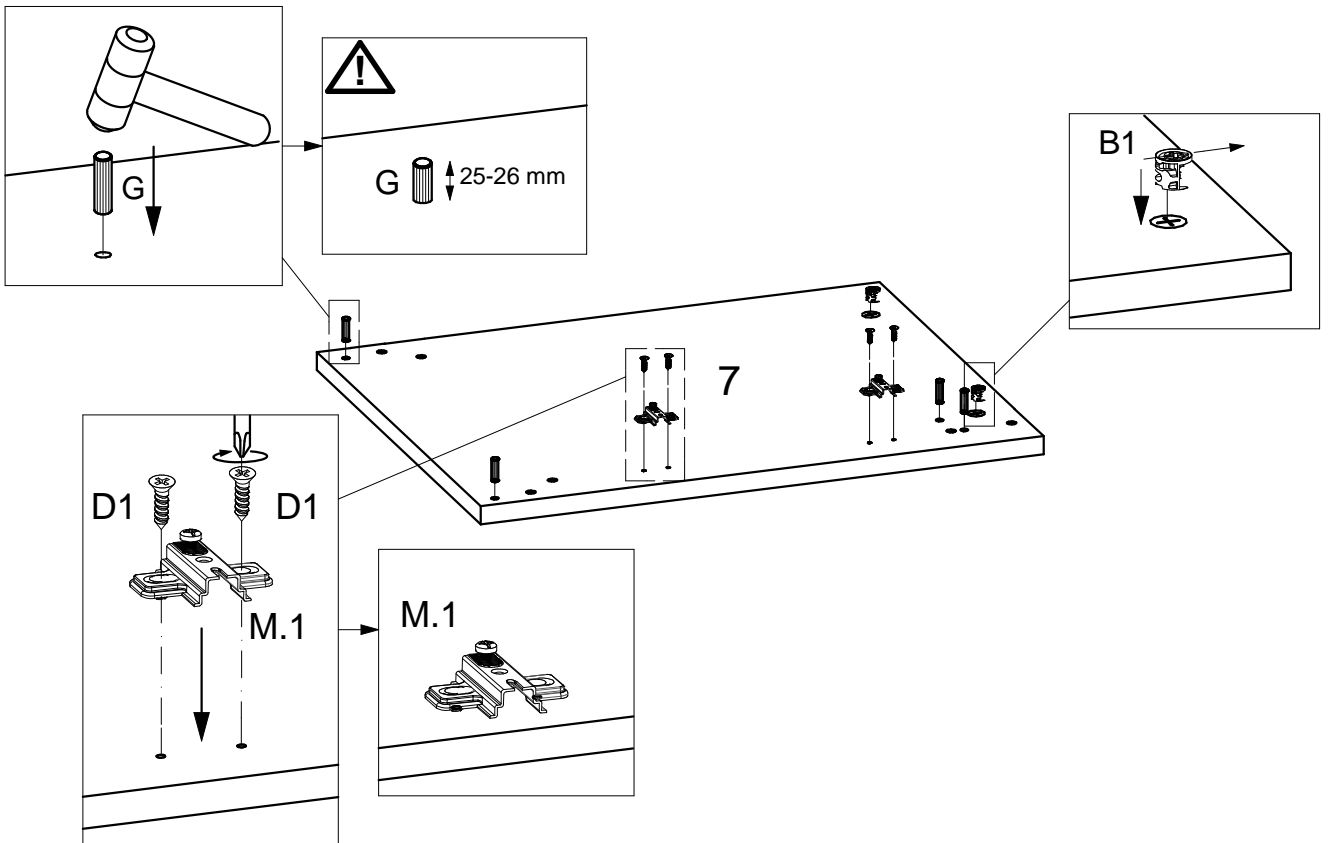
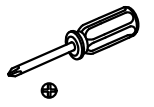
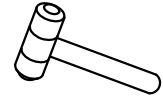

3



B1 x 2



G x 2

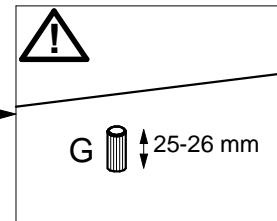
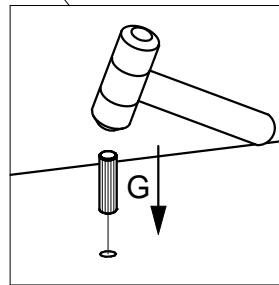
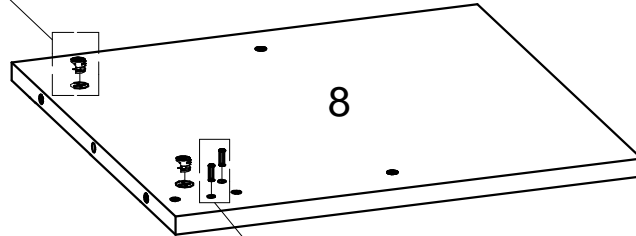
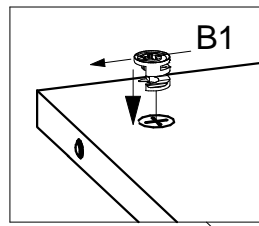
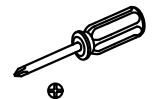
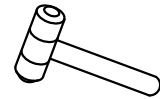

4



B1 x 2



G x 2

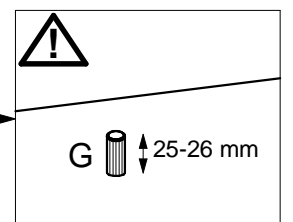
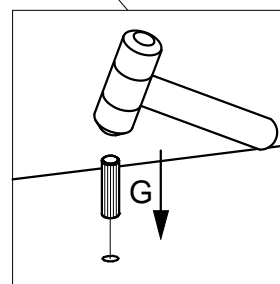
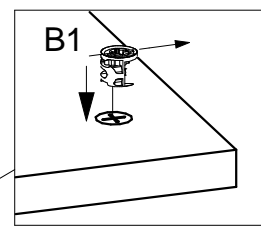
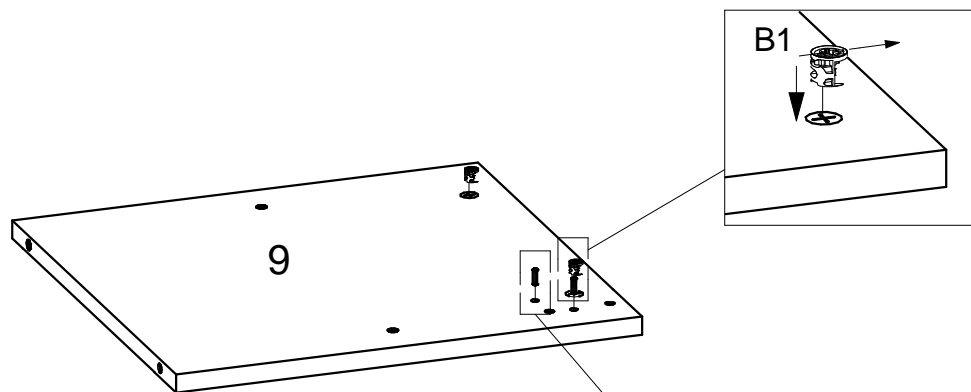
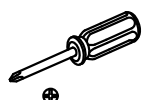
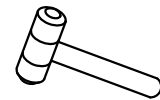

5

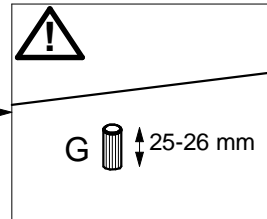
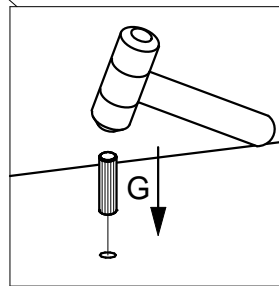
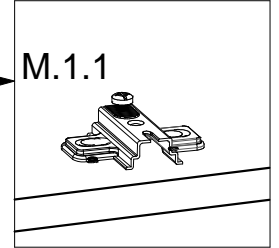
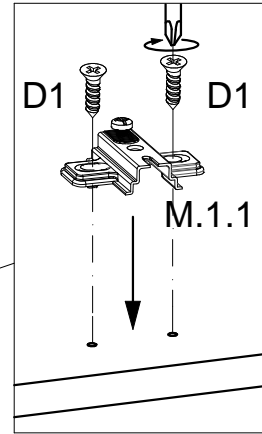
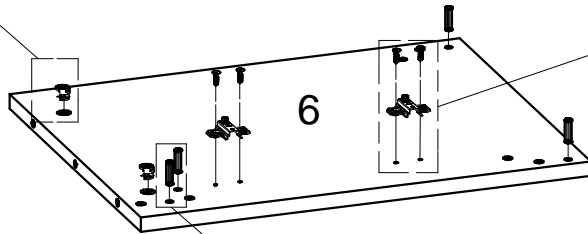
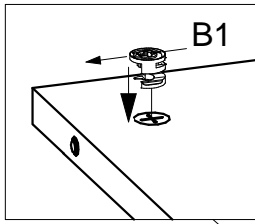
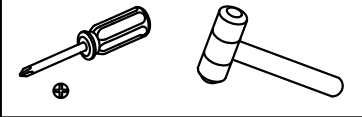
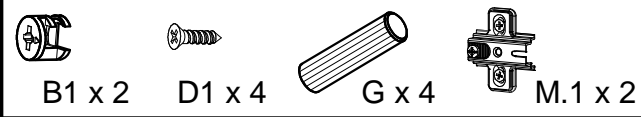

6

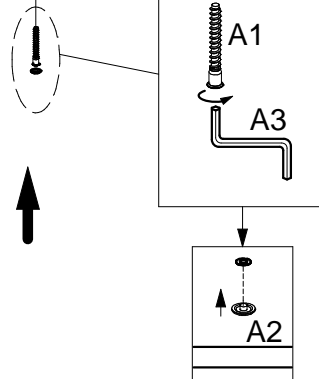
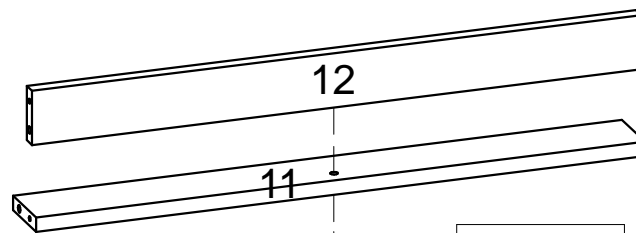
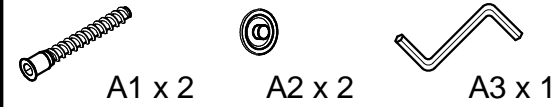

x 2

7



A1 x 4



A2 x 4



A3 x 1

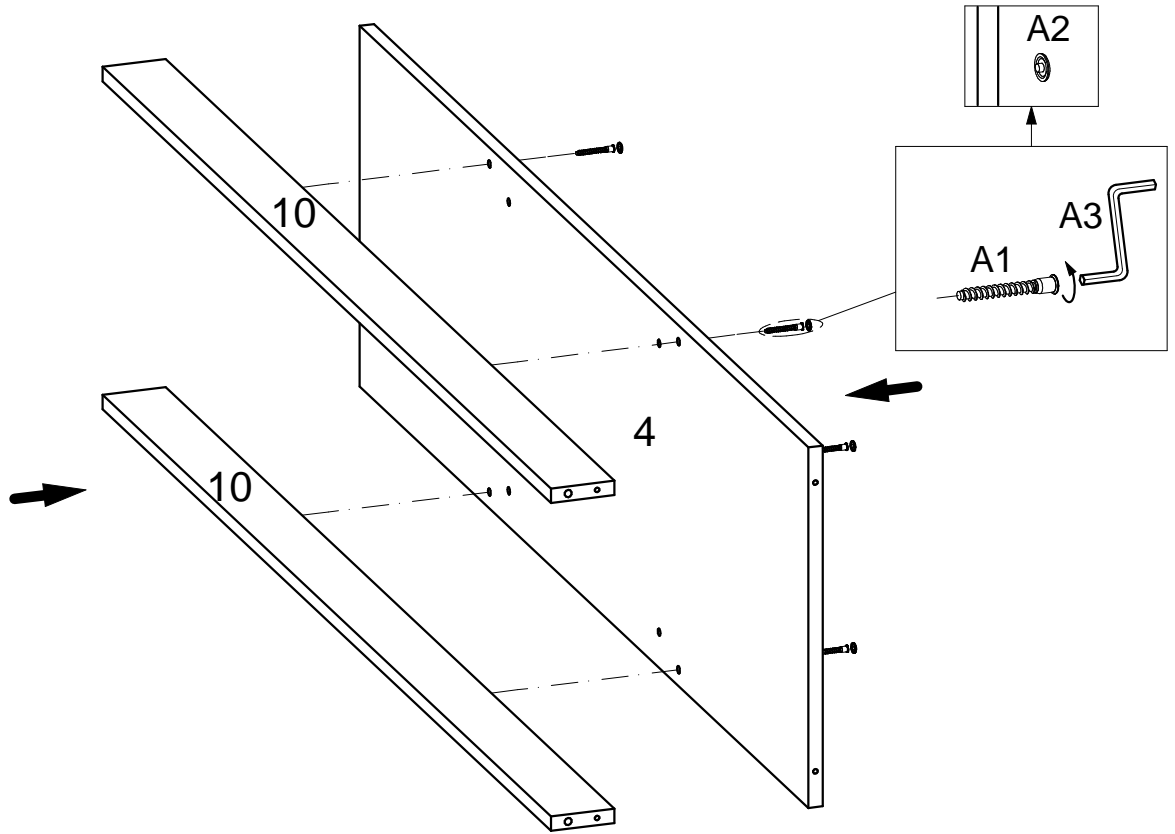

8



A1 x 4



A2 x 4



A3 x 1

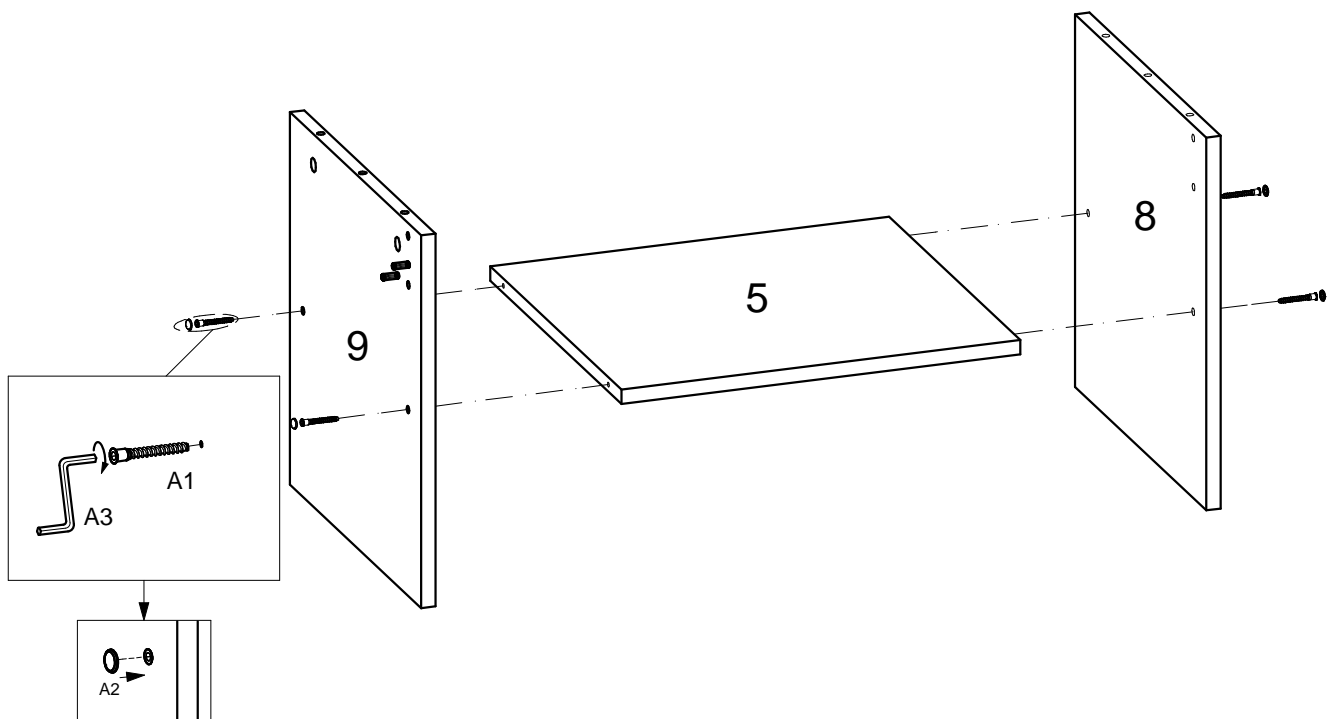

9

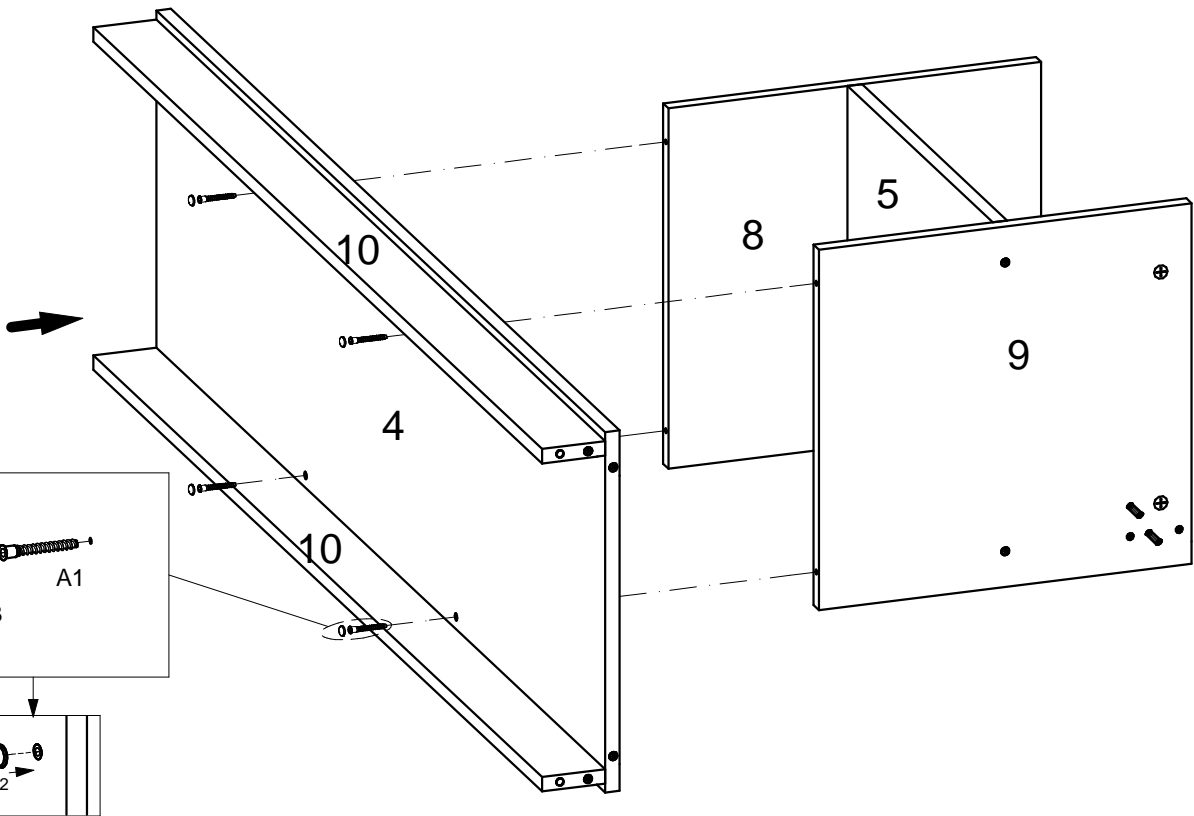
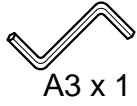
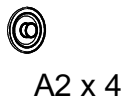
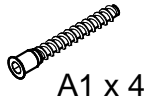

10

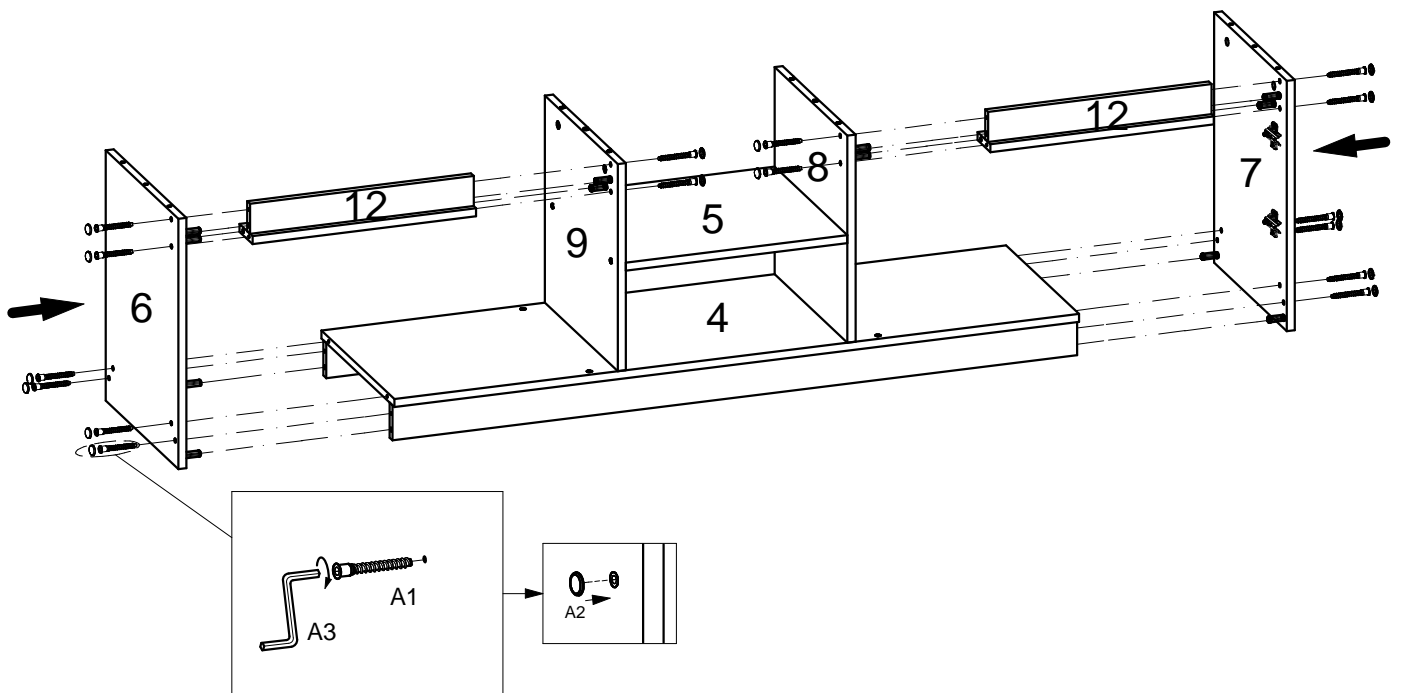
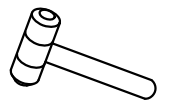
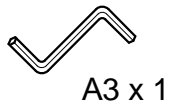
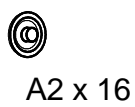
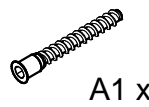

11



B3 x 8

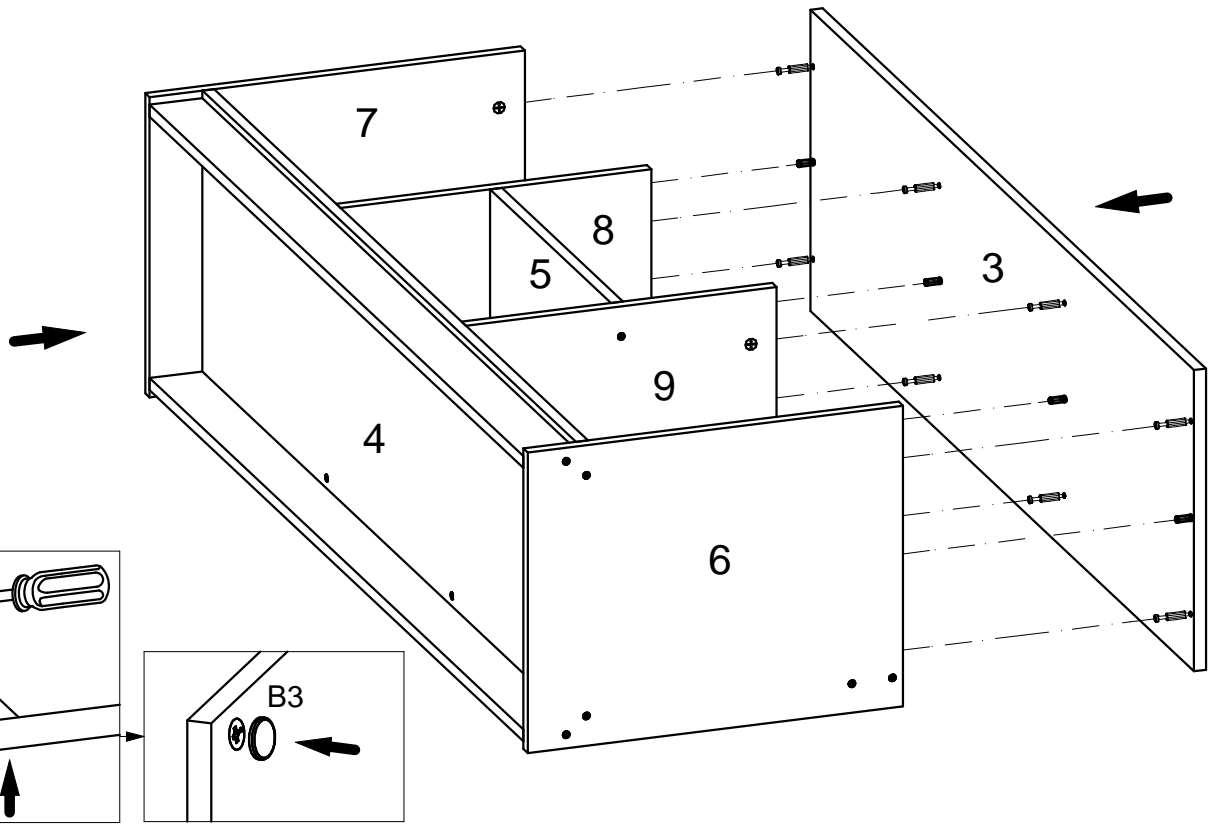
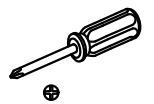
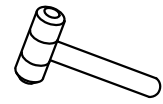

12



D2 x 8

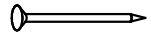

F x 68



N x 8



C x 8

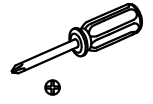
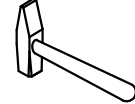

! $XX=YY \cong 90^\circ$

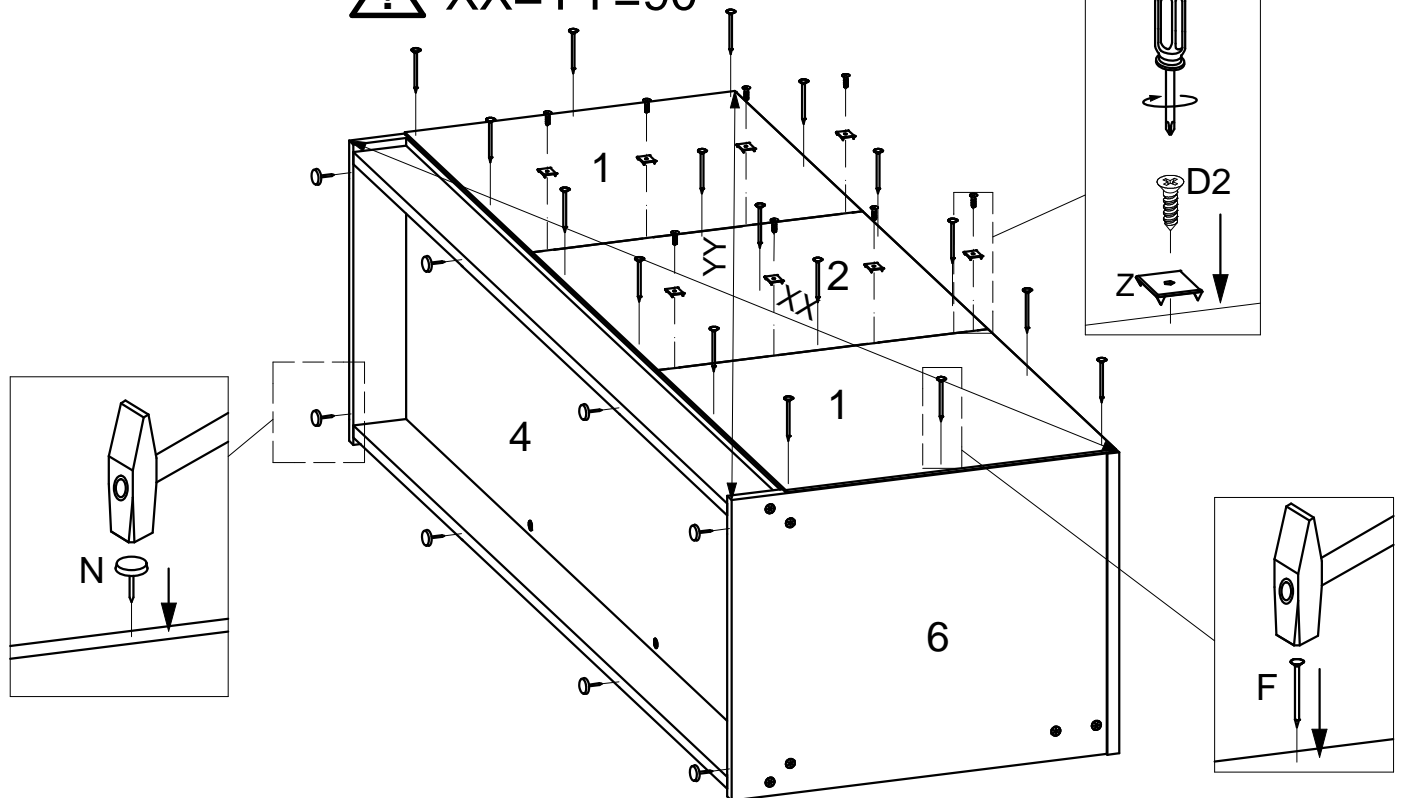

13



D1 x 8

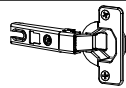

M.2 x 4

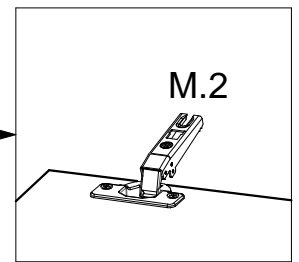
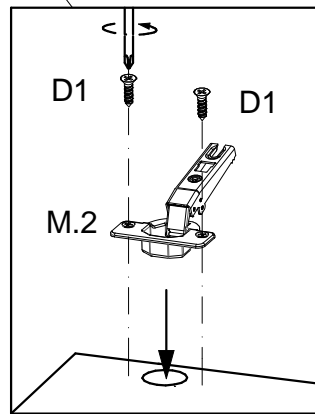
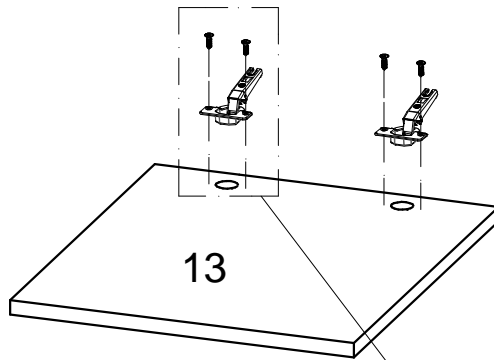
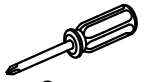

x 2

14

